

CABINET & DRAWER

500/600 series



INTELLECTUAL PROPERTY NOTICE

All trade marks in this catalogue, unless otherwise indicated, are subject to the trade mark rights of Vitally Sdn. Bhd. or its related parties and are registered trade marks in Malaysia and other countries. Vitally Sdn. Bhd. or its related parties protect their marks, brands, model names and logos in all countries in which it uses them.

Certain features and/or functionality of the products and/or systems of Vitally Sdn. Bhd. or its related parties as described in this catalogue are the subject matter of granted certificates for utility innovations or patent applications pending before the Intellectual Property Corporation of Malaysia.

The shape, configuration, pattern and/or ornament of the designs applied onto the products found in this catalogue have, where permissible, been protected by way of registered industrial designs in Malaysia by Vitally Sdn. Bhd. or its related parties.

All materials, including texts, images, logos, designs, graphics, photographs, and other materials that appear as part of this catalogue are properties owned or licensed by Vitally Sdn. Bhd. or its related parties, and are protected by copyright or other intellectual property laws all around the world, and all such rights are reserved. The contents of this catalogue, and the catalogue as a whole, may not be scanned, reproduced, adapted, modified, published, or distributed, in whole or in part, without the prior written consent of Vitally Sdn. Bhd. or its related parties.

Vitally Sdn. Bhd. or its related parties views matters relating to its intellectual property rights and interests seriously and will take the necessary actions to protect and enforce its rights against third parties found to be infringing its rights.

NOTIS HARTA INTELEK

Kesemua cap dagangan yang terkandung dalam katalog ini, melainkan yang dinyatakan sebaliknya, adalah tertakluk kepada hak cap dagangan Vitally Sdn. Bhd. atau pihak-pihak yang berkaitan dengannya dan merupakan cap-cap dagangan berdaftar di Malaysia dan negara-negara lain. Vitally Sdn. Bhd. atau pihak-pihak yang berkaitan dengannya telah melindungi cap, jenama, nama model dan logo kepunyaan mereka di negara-negara di mana mereka menggunakan cap, jenama, nama model dan logo tersebut.

Ciri-ciri dan/atau fungsi tertentu produk dan/atau sistem Vitally Sdn. Bhd. atau pihak-pihak yang berkaitan dengannya sepertimana yang dihuraikan dalam katalog ini merupakan hal perkara bagi siji-siji perbaharuan utiliti yang telah dianugerahkan atau permohonan-permohonan paten yang telah ditailkan dengan Perbadanan Harta Intelek Malaysia.

Ciri bentuk, tatarajah, corak dan/atau hiasan yang digunakan pada produk-produk yang dinyatakan dalam katalog ini telah, di mana ia dibenarkan, dilindungi oleh reka bentuk perindustrian berdaftar di Malaysia oleh Vitally Sdn. Bhd. atau pihak-pihak yang berkaitan dengannya.

Kesemua bahan, termasuk teks, imej, logo, reka bentuk, grafik, gambar dan bahan-bahan lain yang terkandung di mana-mana bahagian katalog ini merupakan harta yang dimiliki oleh atau dilesenkan oleh Vitally Sdn. Bhd. atau pihak-pihak yang berkaitan dengannya dan telah dilindungi oleh hakcipta atau undang-undang harta intelek yang lain di seluruh dunia dan kesemua hak tersebut adalah terpelihara. Kandungan katalog ini, dan katalog ini secara keseluruhannya, tidak boleh dimbas, dikeluarkan semula, diubahsuai, disadur, disesuaikan, diterbitkan, atau diedarkan, sama ada secara keseluruhannya atau sebahagiannya, tanpa keizinan terdahulu secara bertulis dari Vitally Sdn. Bhd. atau pihak-pihak yang berkaitan dengannya.

Vitally Sdn. Bhd. atau pihak-pihak yang berkaitan dengannya memandang serius terhadap perkara-perkara berhubung dengan hak-hak harta inteleknya dan akan mengambil tindakan yang bersesuaian bagi melindungi dan menguatkuasa hak-hak tersebut ke atas pihak ketiga yang didapati melanggar hak-hak tersebut.

知识产权通告

本产品目录册中的所有商标, 皆受制于 Vitally Sdn. Bhd.或其相关方的商标权, 并于马来西亚与其他国家受承认为注册商标, 除非另有说明。所有 Vitally Sdn. Bhd.或其相关方正在使用的商标, 品牌, 型号名称与标志, 皆已于相关国家受保护。

本产品目录册中所描述并属于 Vitally Sdn. Bhd.或其相关方的产品和/或系统的特定特征和/或特定功能, 乃 Vitally Sdn. Bhd.或其相关方已成功注册为实用新型专利中的发明元素或已呈交于马来西亚知识产权局的专利申请中的发明元素。

所有应用于本产品目录册中所描述的产品上之形状、配置、图案和/或设计, 在被允许的情况下, 已在马来西亚获得 Vitally Sdn. Bhd.或其相关方名下的工业设计注册之保护。

所有素材, 包括文字、图像、标志、设计、图形设计、照片, 以及其它在本产品目录册中所使用的素材皆由 Vitally Sdn. Bhd.或其相关方所拥有或授权, 并在世界各地受到版权或其它知识产权法律的保护。我们一律保留所有相关权益。本产品目录册的内容以及整体目录册, 无论是整体或部分, 在未获得 Vitally Sdn. Bhd.或其相关方的预先书面同意之下, 一律不得被扫描、复制、改编、修改、发布或分发。

Vitally Sdn. Bhd.或其相关方严谨看待其知识产权与权益。为了保护并执行有关产权与权益, 我们将采取必要的行动以杜绝第三方的任何侵权行为。



500 series

CABINET

Aerolite Panel: ASD 107 / AWG 203

IMPRESSIVE KITCHEN DESIGN IDEAS

Vitaly cabinets with truly innovative designs express refined style, great practicality and convincing durability assurance. Apart from having incomparable premium quality, Vitaly cabinets will add a subtle elegance to your kitchen that will never go out of style. Both Vitaly's Swing Cabinet Series offering you the flexibility to create a unique, stylish and dedicated functional kitchen. Ultimately, it can be customized fulfilling your requirements to best utilize your space and provide the perfect and accessible storage solution.

Types of Cabinet

510B

SWING CABINET SERIES

590B

CABINET SHELF PANEL
SERIES

510B SWING CABINET SERIES

Delightful J-shape handle reflects a minimalist and timeless design, which the popularity is set to increase, as it enables limitless kitchen design possibilities. It helps to accentuate a linear design for your cabinet door and drawer front to get a continuous and streamlined look.

Only available for CD112 / CD114 / CD116, please refer to page 11.

511B

SWING CABINET FRONT SET



OUTER FRAME DESIGN

Top Profile, Adjustable Bar & DIY Nuts

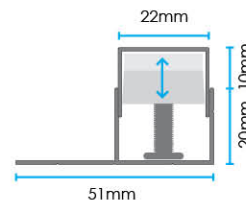

L-Shape Profile

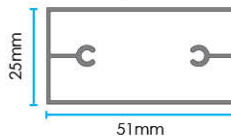

Bottom & Side Profile

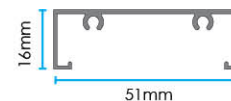

Centre Profile

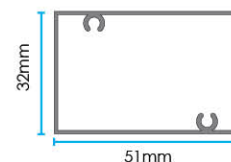

512B

SWING CABINET DOOR*

* Include Hinge Systems



HINGE SYSTEMS

Smooth and silent door operation.



Hydraulic Hinge



Aerolite Panel: AWG 218

590B CABINET SHELF PANEL SERIES

There are Full Aluminium Shelf Panel and Semi Aluminium Shelf Panel available to meet your individual requirements. Full Aluminium Shelf Panel is fully fabricated with aluminium extrusion, whereas Semi Aluminium Shelf Panel consists high quality 4mm composite panel to provide maximum strength and longevity of durability.

591B

Full Aluminium Shelf Panel

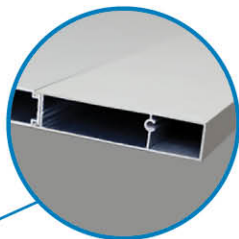

PROFILE DESIGN

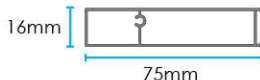

PROFILE COLOUR

NA

592B

Semi Aluminium Shelf Panel

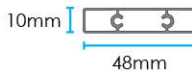
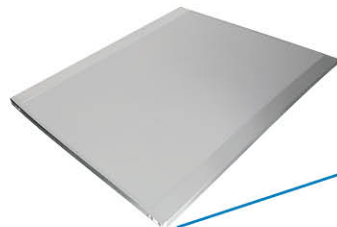

PROFILE COLOUR

NA

Aluminium Composite Panel
Thickness: 4mm



600 *series*

DRAWER

Eco Art Panel: C131860 - C131865

Vitaly introduces design oriented ideas that make drawers a key element in your kitchen storage solutions. Vitaly Drawer emphasizes perfection in neat organization, easy accessibility and outstanding appearance. Both of the structural designs bring efficiency to each drawer in your kitchen by ensuring smooth operation and full extension, optimal storage space, enhanced load capacity and wide range of design options.

TYPES OF DRAWER

610B

FULL ALUMINIUM DRAWER SERIES

620B

SEMI ALUMINIUM DRAWER SERIES

610B

FULL ALUMINIUM DRAWER SERIES

Only available for CD112 / CD114 / CD116,
please refer to page 11.

OUTER FRAME DESIGN

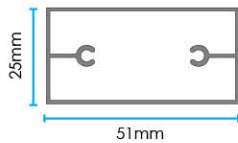

Side Profile

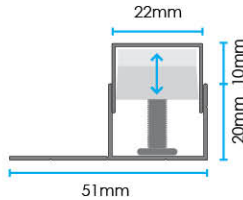

Top Profile, Adjustable Bar
& DIY Nuts

DRAWER BOX DESIGN

For more information about Drawer Box, please refer to
pages 9.



Aluminium Extrusion Drawer Box

MINIMUM HEIGHT REQUIREMENT

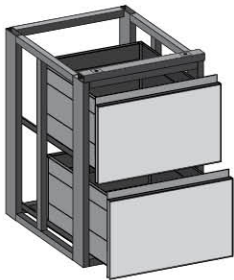

615B

2 DRAWERS
571mm (22 7/16")

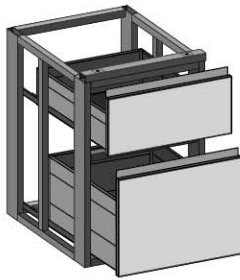

611B

2 DRAWERS
469mm (18 7/16")

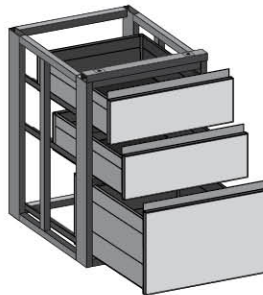

612B

3 DRAWERS
649mm (25 9/16")

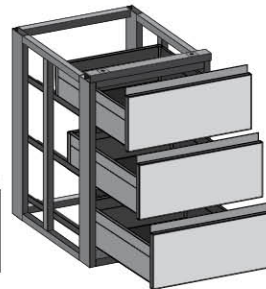

613B

3 DRAWERS
565mm (22 4/16")

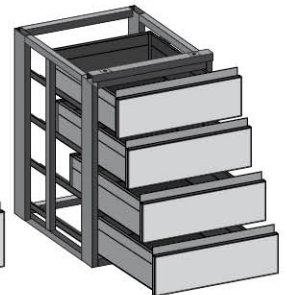

614B

4 DRAWERS
751mm (29 9/16")



620B

SEMI ALUMINIUM DRAWER SERIES

Only available for CD112 / CD114 / CD116,
please refer to page 11.

OUTER FRAME DESIGN

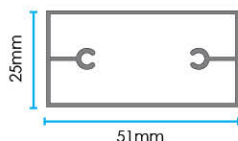

Side Profile

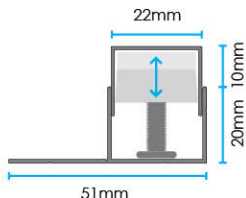

Top Profile, Adjustable Bar
& DIY Nuts

DRAWER BOX DESIGN

For more information about Drawer Box, please refer to
pages 10.



Composite Panel Drawer Box

MINIMUM HEIGHT REQUIREMENT

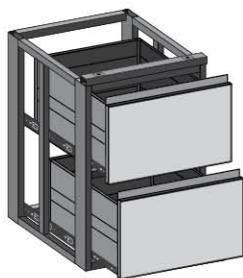

625B

2 DRAWERS
545mm (21 7/16")

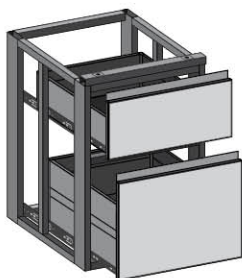

621B

2 DRAWERS
439mm (17 4/16")

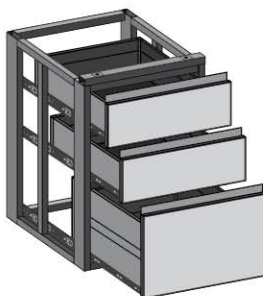

622B

3 DRAWERS
603mm (23 12/16")



623B

3 DRAWERS
493mm (19 6/16")

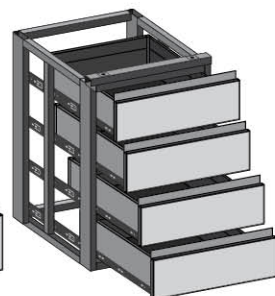

624B

4 DRAWERS
655mm (25 12/16")

DRAWER BOX SERIES

ALUMINIUM EXTRUSION DRAWER BOX Only available for Model 610B.

Vitality Aluminium Extrusion Drawer Box System is fully fabricated with aluminium extrusion to ensure high stability and durability even when continuous loading and heavy duty usage. Our distinctive designed full extension light grey drawer system enables you to plan the drawer contents just as you wish and always ready to hand.

ROUNDED INNER EDGE

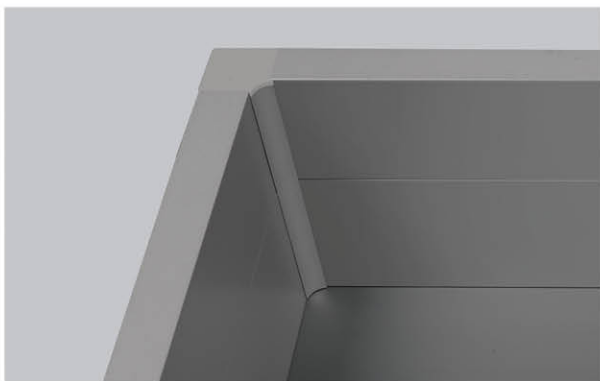

PROFILE DESIGN

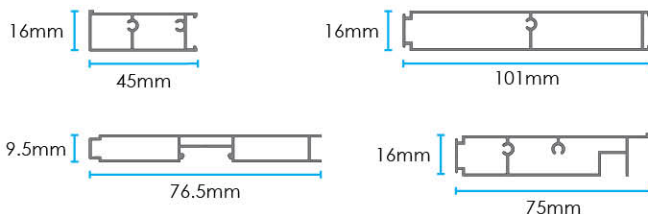

DRAWER RUNNER SYSTEMS



Undermount Runner Set (Soft Closing)

STORAGE SIZE

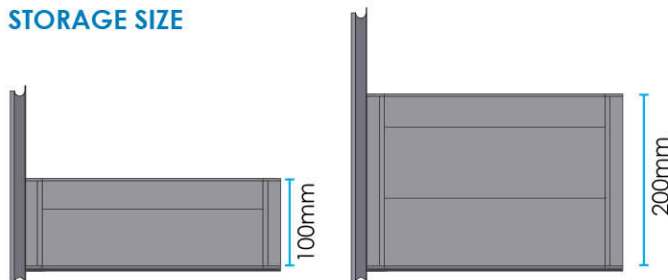

DRAWER BOX COLOUR

PCLG



COMPOSITE PANEL DRAWER BOX Only available for Model 620B.

Vitality Composite Panel Drawer Box System is an attractive and functional alternative with unsurpassed quality to meet your specific needs.



PROFILE DESIGN



- ① Front & Back Panel Thickness: 1.3mm
- ② Aluminium Composite Panel (Bottom) Thickness: 3mm

STORAGE SIZE

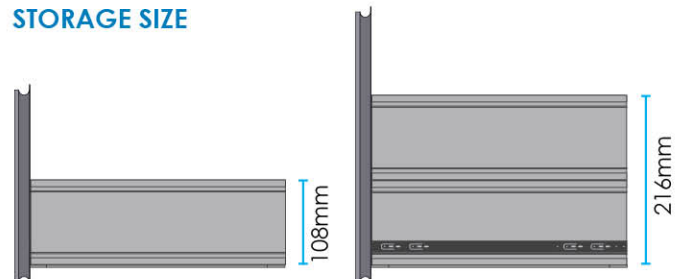

DRAWER RUNNER SYSTEMS



Drawer Slide (Without Soft Closing)

DRAWER BOX COLOUR



TYPE OF CABINET DOOR

FINGER GROOVE CABINET DOOR

- Hassle-free to operate.
- Durable and easy to clean.
- Sleek and seamless facade.
- Fit in for all design styles
- from traditional to contemporary.



aerolite[®]

Applicable to 3mm Aerolite Panel

FRAME COLOUR

PCW

NA

PCMB

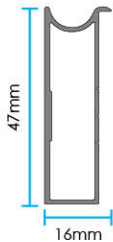

CD 113
(LG)

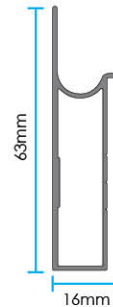

CD 114
(LG)





Eco Art Panel : C131986-C131991 / C131866-C131871

Lamina

Applicable to 4mm Lamina Glass

FRAME COLOUR

PCW

NA

PCMB

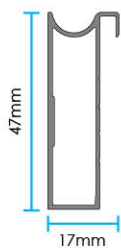

CD 115
(CG)

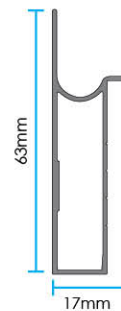

CD 116
(CG)

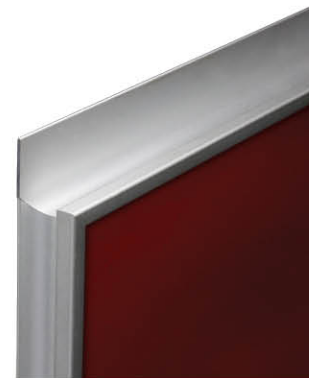



aerolite[®]

eco[®]
ART PANEL

vitally[®]

Applicable to 3mm Aerolite Panel, Eco Art Panel & VACP

FRAME COLOUR

PCW

NA

PCMB

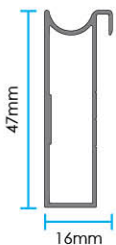

CD 111
(CG)

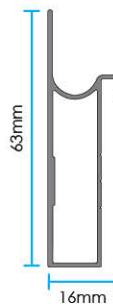

CD 112
(CG)



INDEX

SINK INSTALLATION PROCESS

Resizing or modifications is made easy for kitchen sink installation process.



Step 1 Cut & Fold



Step 2 Fold Down



Step 3 Remove

VENTILATION PANELS

ACP FLAT VENTS

- Applicable to Aluminium Composite Panel only.



FLASH SILVER
CV 10

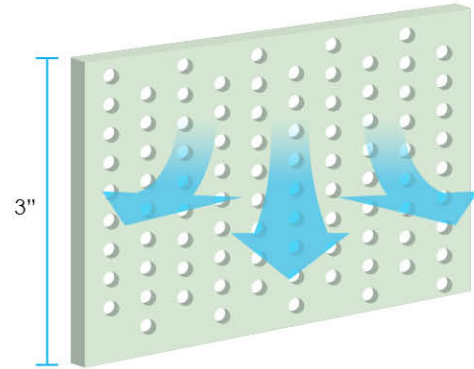

INFILL PANEL

ECO ART PANEL



SCAN ME
FOR MORE DESIGNS.

Visit our website for more designs:
www.vitally.com.my/e-catalog-category/eco-art-panel/

ALUMINIUM COMPOSITE PANEL



FLASH SILVER
VACP 10D



FLASH GOLD
VACP 11D



SNOW WHITE
VACP 12D



CREME BEIGE
VACP 13D



CREAMY GREEN
VACP 14D



SPRING GREEN
VACP 15D



LAGOON BLUE
VACP 16D

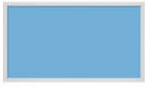

PORCELAIN BLUE
VACP 17D



TROPIC BLUE
VACP 18D



IVORY ROSE
VACP 19D



AMAZON RED
VACP 20D



DARK CHOCOLATE
VACP 21D



CHARCOAL GREY
VACP 22D



BOSIC BLACK
VACP 23D

LAMINA GLASS

ILLUSION
SERIES
(METALLIC)



MS-1009
GOLDEN SAND



MS-1017
BLUEBELLS

TITAN
SERIES
(METALLIC)



MT-2001
TITAN RED



MT-2006
TITAN SILVER

SOLID
SERIES



SD-3001
SNOW WHITE



SD-3009
BLACK SEA

WOODGRAIN
SERIES



WG-4001
SKYLINE



WG-4002
SUNLINE

GALAXY
SERIES



GX-5001
GALAXY WHITE



GX-5002
GALAXY GREEN

TRANSLUCENT
SERIES



TC-6501
FROSTED CLEAR



TC-6502
FROSTED WHITE

FANCY
SERIES



FC-7001
FLOW BLACK



FC-7002
FLOW WHITE

AEROLITE PANEL



SALISBURY STONE
ASD 107



LIGHT GREY
ASD 110

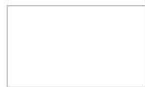

SNOW WHITE
ASD 112



GRAPHITE
ASD 122



BLACK
ASD 123



FINELINE
AWG 201



WATERFALL LINE
AWG 203



ALABASTER OAK
AWG 204



NATURAL ASH
AWG 205



SMOKED PINE
AWG 210



BURMESE TEAK
AWG 212



HAZELNUT CHERRY
AWG 216







OILED OLIVEWOOD
AWG 218



BLACKEN LEGNO
AWG 230

SPECIFICATIONS

	500 SERIES CABINET			
Model	510B Swing Cabinet		590B Cabinet Shelf Panel	
Sub Model	511B Swing Cabinet Front Set	512B Swing Cabinet Door	591B Full Aluminium Shelf Panel	592B Semi Aluminium Shelf Panel
Infill Panel	<ul style="list-style-type: none"> • Aerolite Panel • Eco Art Panel • Aluminium Composite Panel • Lamina Glass 		-	-
Featured Accessories	<ul style="list-style-type: none"> • Outer Frame • Adjustable Bar • DIY Nuts • Hydraulic Hinge 	<ul style="list-style-type: none"> • Hydraulic Hinge 	-	-
	<ul style="list-style-type: none"> • Clip top Blumotion 107° Hinge(Optional) 			
Frame Design	• CD 112	• CD 114	• CD 116	-
Ventilation Panel	• ACP Flat Vents	-	• ACP Flat Vents	-
Colour	 Powder Coating White	 Natural Anodised	 Powder Coating Matt Black	 Natural Anodised
Warranty*	10 Years <ul style="list-style-type: none"> • Outer Frame • Adjustable Bar • DIY Nuts • Clip top Blumotion107° Hinge 		10 Years	3 Years
	1 Year <ul style="list-style-type: none"> • Hydraulic Hinge • All Types of Infill Panel 			

Specifications are subject to change without prior notice.

600 SERIES DRAWER	
Model	<div style="display: flex; justify-content: space-around;"> <div style="text-align: center;"> 610B Full Aluminium Drawer </div> <div style="text-align: center;"> 620B Semi Aluminium Drawer </div> </div>
Sub Model	<div style="display: flex; justify-content: space-around;"> <div style="text-align: center;"> • 611B • 612B • 613B • 614B • 615B </div> <div style="text-align: center;"> • 621B • 622B • 623B • 624B • 625B </div> </div>
Infill Panel	<ul style="list-style-type: none"> • Aerolite Panel • Eco Art Panel • Aluminium Composite Panel • Lamina Glass
Featured Accessories	<ul style="list-style-type: none"> • Outer Box • Adjustable Bar • DIY Nuts
Drawer Box	<div style="display: flex; justify-content: space-between;"> <div style="width: 45%;"> <ul style="list-style-type: none"> • Aluminium Extrusion Drawer Box • Undermount Runner Set (Soft Closing) <p>Optional _____</p> <ul style="list-style-type: none"> • Blumotion Runner Set (Soft Closing) </div> <div style="width: 45%;"> <ul style="list-style-type: none"> • Composite Panel Drawer Box • Drawer Slide (Without Soft Closing) </div> </div>
Frame Design	<div style="display: flex; justify-content: space-around;"> <div>• CD 112</div> <div>• CD 114</div> <div>• CD 116</div> </div>
Colour	<div style="display: flex; justify-content: space-around; align-items: center;"> <div style="border: 1px solid black; border-radius: 50%; width: 30px; height: 30px; background-color: white; display: flex; align-items: center; justify-content: center;">PCW</div> <div style="border: 1px solid black; border-radius: 50%; width: 30px; height: 30px; background-color: gray; display: flex; align-items: center; justify-content: center;">NA</div> <div style="border: 1px solid black; border-radius: 50%; width: 30px; height: 30px; background-color: black; display: flex; align-items: center; justify-content: center; color: white;">PCMB</div> </div>
Warranty* <small>* Terms & Condition Apply</small>	<div style="display: flex; justify-content: space-between;"> <div style="width: 45%;"> <p>10 Years</p> <ul style="list-style-type: none"> • Outer Frame • Drawer Box • Adjustable Bar • DIY Nuts • Blumotion Runner Set <p>1 Year</p> <ul style="list-style-type: none"> • Undermount Runner Set • All Types of Infill Panel </div> <div style="width: 45%;"> <p>3 Years</p> <ul style="list-style-type: none"> • Outer Frame • Drawer Box • Adjustable Bar • DIY Nuts <p>1 Year</p> <ul style="list-style-type: none"> • Drawer Slide • All Types of Infill Panel </div> </div>



Our Quality Assurance:



Our Awards & Achievements:



www.vitally.com.my

 Vitally   vitality_official

CDB-BR003-1914 C

Authorised Dealer: